



MODELL SANTA FE

SOFA - OTTOMANE

GB ASSEMBLY INSTRUCTIONS
INSTRUKTION MANUAL

DE MONTAGEANLEITUNG
BEDINUNGSANLEITUNG

HU SZERELÉSI ÚTMUTATÓ
HASZNÁLATI UTASÍTÁS

FR NOTICE DE MONTAGE
MANUEL INSTRUCTIONS

RO INSTRUCȚIUNI DE INSTALARE
INSTRUCȚIUNI DE UTILIZARE

NL HANDLEIDING VOOR DE MONTAGE
GEBRUIKAANWIJZING

CZ MONTÁŽNÍ NÁVOD
NÁVOD K OBSLUZE

HR UPUTE ZA MONTAŽU
UPUTE ZA UPOTREBU

IT ISTRUZIONI DI MONTAGGIO
MANUALE DI ISTRUZIONI

RU ИНСТРУКЦИЯ ПО МОНТАЖУ
ИНСТРУКЦИЯ

SK MONTÁŽNY NÁVOD
NÁVOD NA OBSLUHU

ES INSTRUCCIONES DE MONTAJE
MANUAL DEL USUARIO

PT INSTRUÇÕES DE MONTAGEM
MANUAL DO USUÁRIO

TR MONTAJ TALIMATI
KILAVUZUNU

PL INSTRUKCJA MONTAŻU
INSTRUKCJA OBSŁUGI

SI NAVODILA ZA MONTAŽO
NAVODILA ZA UPORABO

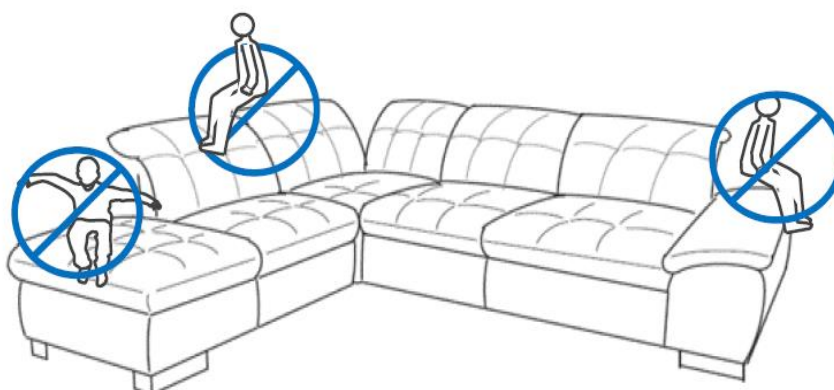
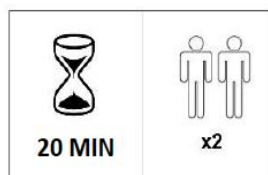
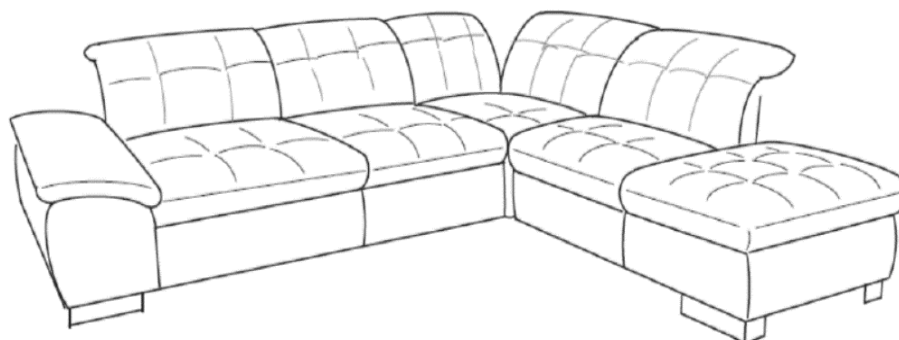

1

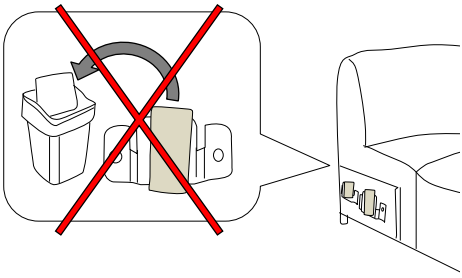

2

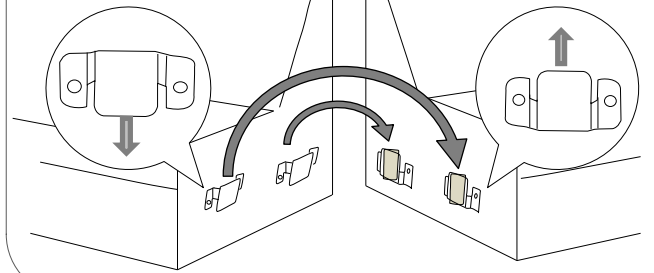

BITTE DIE TRANSPORTSICHERUNG ENTFERNEN

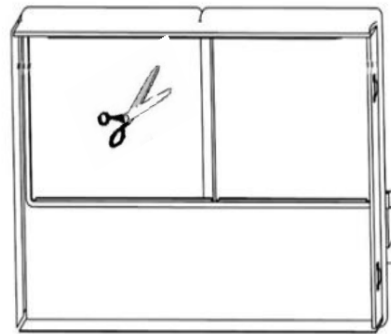
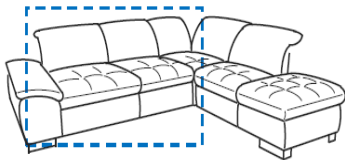

FUNKTION AUSZIEHBETT

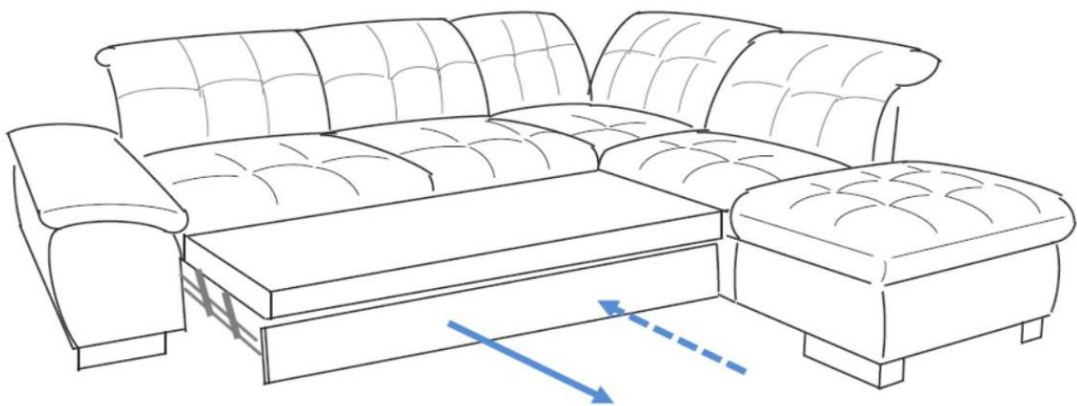

FUNKTION SCHWENKRUCKEN

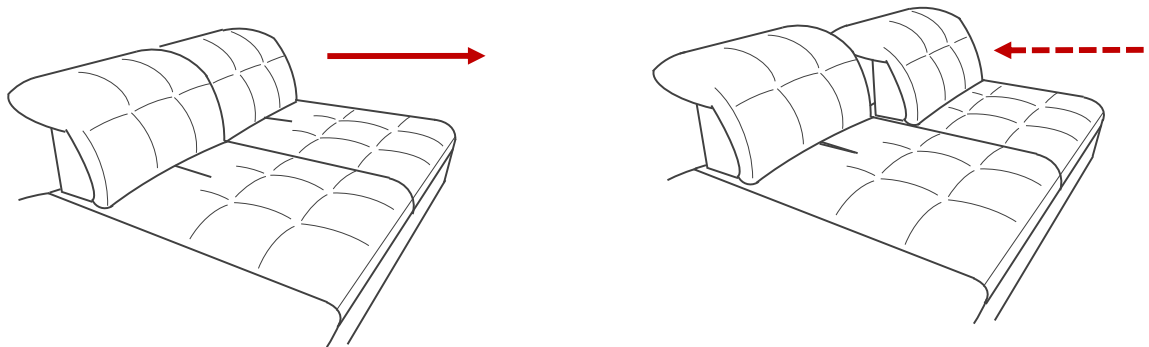

FUNKTION ARMTEIL KLAPPBAR

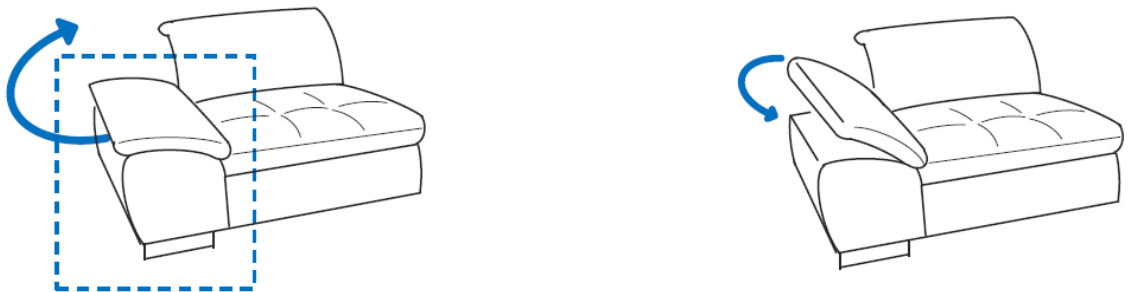

ABSCHLUSSELEMENT BETTKASTEN

